

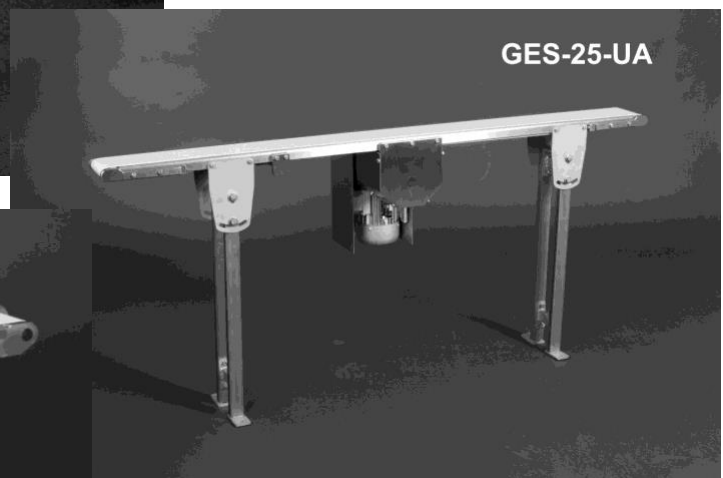

## GES-25 Series Conveyors Operating Manual



Also applies to:  
**GES-25-RMK**  
**GES-25-UA-RMK**  
**GES-25-UA**



**Please read carefully  
before use of  
machine !!!**

**Dorner GmbH**  
Karl-Heinz-Beckurts-Str. 7  
D-52428 Jülich  
Germany

Phone: +49 2461 93767 0  
Fax: +49 2461 93767 30

E-Mail: [info.europe@dorner.com](mailto:info.europe@dorner.com)  
Web: [www.dorner.com](http://www.dorner.com)

Table of contents:

- 1 Introduction ..... 4
- 2 Safety during handling of our belt conveyors..... 4
  - 2.1 Safety equipment on our belt conveyors ..... 4
  - 2.2 General advice for the correct handling of belt conveyors ..... 4
  - 2.3 Duties of the operator ..... 5
  - 2.4 Safety trade marks..... 5
- 3 Dimensions and technical data ..... 6
  - 3.1 Basic dimensions ..... 6
  - 3.2 Belts ..... 8
  - 3.3 Motors ..... 9
    - 3.3.1 Geared motor, type SN5FR:..... 9
    - 3.3.2 Geared motor, type SN3F small flange: ..... 10
  - 3.4 Electrical equipment ..... 11
    - 3.4.1 Frequency converter..... 11
    - 3.4.2 Motor overload switch..... 12
    - 3.4.3 Emergency-stop-switch ..... 13
- 4 Adjustments ..... 14
  - 4.1 Drives ..... 14
    - 4.1.1 Drive underneath the belt ..... 14
    - 4.1.2 Side mounted drive..... 14
  - 4.2 Belt alignment ..... 16
    - 4.2.1 Deflecting roller:..... 17
    - 4.2.2 Drive roller: ..... 17
    - 4.2.3 Knife edge..... 17
    - 4.2.4 Lower drive of GES-25-UA ..... 18
  - 4.3 Supports..... 19
    - 4.3.1 Protection against tip-over of flat belt conveyors ..... 19
    - 4.3.2 Two-legged aluminium support ..... 20
    - 4.3.3 Two-legged aluminium support, short version ..... 20
    - 4.3.4 Two-legged steel support ..... 21
    - 4.3.5 Two-legged steel support, short version ..... 21
    - 4.3.6 Short steel support held from side..... 22
    - 4.3.7 Two-legged stainless steel support ..... 22
    - 4.3.8 Single-legged steel support with aluminium base plate ..... 23
    - 4.3.9 Steel H-shaped single-legged support ..... 23
    - 4.3.10 Steel H-shaped single-legged support with castors ..... 24
    - 4.3.11 Stainless steel H-shaped single-legged support ..... 24
    - 4.3.12 Stainless steel H-shaped single-legged support with castors..... 24
- 5 Spare parts..... 24

## Table of figures:

Figure 3-1:	Basic dimensions GES-25.....	6
Figure 3-2:	Basic dimensions GES-25-UA .....	6
Figure 3-3:	Basic dimensions GES-25-RMK .....	7
Figure 3-4:	Table on belt types .....	8
Figure 3-5:	Frequency converter.....	11
Figure 3-6:	Connection of frequency converter to motor .....	11
Figure 3-7:	Motor overload switch.....	12
Figure 3-8:	Connection of overload switch to motor .....	12
Figure 3-9:	Emergency-stop-switch .....	13
Figure 3-11:	Connection of emergency-stop-switch to 380V 50Hz .....	13
Figure 3-10:	Connection of emergency-stop-switch to 230V 50Hz .....	13
Figure 4-1:	Dismounting side motor .....	14
Figure 4-2:	Adjustment of clutch play .....	14
Figure 4-3:	Rotated installation positions of the motor .....	15
Figure 4-4:	Belt reaction to different bracket positions .....	16
Figure 4-5:	Tracking of belt using supporting rollers .....	16
Figure 4-6:	Belt alignment at deflecting roller .....	17
Figure 4-7:	Belt alignment at drive roller .....	17
Figure 4-8 :	Removal of lower drive casing cover .....	18
Figure 4-9 :	Adjustment of lower drive belt track.....	18
Figure 4-10:	Maximum weight at end of conveyor with supports on wheels .....	19
Figure 4-11:	Two-legged aluminium support, height adjustment.....	20
Figure 4-12:	Two-legged aluminium support, inclination adjustment.....	20
Figure 4-13:	Two-legged steel support, height adjustment.....	21
Figure 4-14:	Two-legged steel support, inclination adjustment .....	21
Figure 4-15:	Short steel support held from side, height adjustment .....	22
Figure 4-16:	Single-legged steel support with aluminium base plate, height adjustment.....	23
Figure 4-17:	Single-legged steel support with aluminium base plate, inclination adjustment .....	23
Figure 4-18:	Steel H-shaped single-legged support, brake .....	24

## 1 Introduction

Our belt conveyors are provided for inside use only; they are not suitable for damp and wet locations or areas exposed to danger of explosion. However special versions, which are suitable for such areas, can be supplied after consultation and confirmation.

Maintenance of the belt conveyors is limited to an occasional check of the running of the belt. To adjust the belt we recommend strongly to observe the advice given in this operating manual.

## 2 Safety during handling of our belt conveyors

All our standard belt conveyors were designed with special emphasis on safety. Specially during operation of the belt conveyors, unnecessary risks have to be avoided. Thus the design of many components has been carried out in such a way that the risk to injury of the operating personnel is minimised.

### 2.1 Safety equipment on our belt conveyors

One of the most frequent type of accidents when working on or with conveyors is injury sustained to parts of the body which are caught between the circulating belt and the rotating rollers. To make these accidents impossible or to minimise this risk to the widest extent, all Dorner belt conveyors are equipped with a gap protection wherever the belt runs over a roller. This gap protection is designed in such a way that during adjustment work it is automatically positioned in correct relation to the roller.

To avoid damages to electrical equipment and to minimise the risk of electrical shock, all parts of our belt conveyors are connected to earth.

For all our belt conveyors we provide a safety switch which cuts-off the current to the unit automatically in the case of overload or overheating. In addition to that each conveyor has an emergency-stop-switch to switch-off the belt conveyor quickly in any case of emergency. See also section 3.4.

If a belt conveyor is delivered without safety switch or emergency stop switch, the operator must ensure a correct set-up of the machine and provide an opportunity to stop the belt in case of emergency.

### 2.2 General advice for the correct handling of belt conveyors

Any work or installation on the mechanical part of the conveyors may only be carried out by a mechanic or personnel with equivalent education or indoctrination. Any work or installation on the electrical part of the conveyors may only be carried out by an electrician or personnel with equivalent education or indoctrination.

The operators and all personnel working on or with a conveyor should wear suitable protective clothing. That includes safety shoes for protection against falling objects as well as tight fitting clothes and hair nets for people with long hair to minimise the risk of getting caught in the belt.

A functional test of the security-stop-switch should be performed daily. That includes a test of the protection against uncontrolled restart after a voltage drop. The conveyor may not start by it self after a voltage drop. It may only start after the actuation of a button.

The working height should be adjusted to an ergonomic level, if that is possible and wanted.

Touching the belt while it is running is prohibited. People may not be transported on the belt.

In case of an emergency the belt of the conveyor can be moved backwards by pulling on it.

## 2.3 Duties of the operator

The operator of a conveyor has to make sure that all requirements for a safe operation of the device are met. Therefore the following has to be taken into account:

- There has to be sufficient lighting at each persons workplace.
- The conveyors can only be used in inside areas.
- The maximum weights must not be exceeded. With this the danger of tipping over a conveyor on supports with wheels has to be taken into account.
- Accessory added later must not endanger the operators.

## 2.4 Safety trade marks

Some of our standard belt conveyors can be equipped with special safety trade marks. These will be attached to the machine on request.

Based on an individual application of the belt conveyor, an individual adaptation may be required. This can be provided by us as the manufacturer or by the client himself. In both cases, a cancellation of the validity of the safety trade mark may be the result.

### 3 Dimensions and technical data

#### 3.1 Basic dimensions

The most important dimensions of the belt conveyor GES-25, GES-25-UA and GES-25-RMK are shown in the following figures:

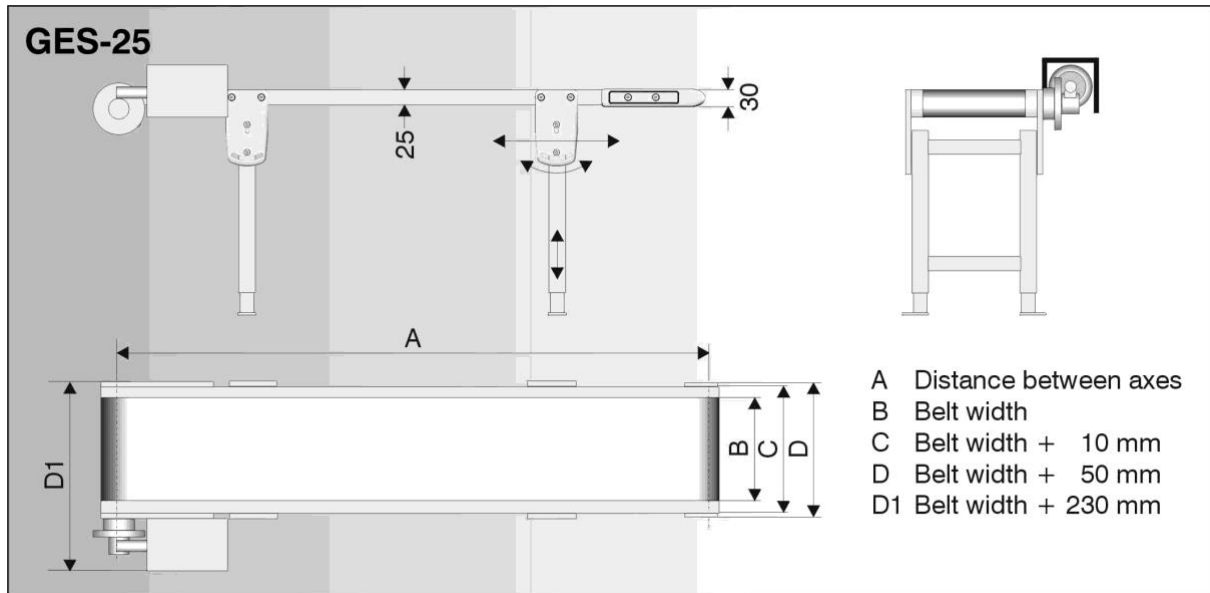

Figure 3-1: Basic dimensions GES-25

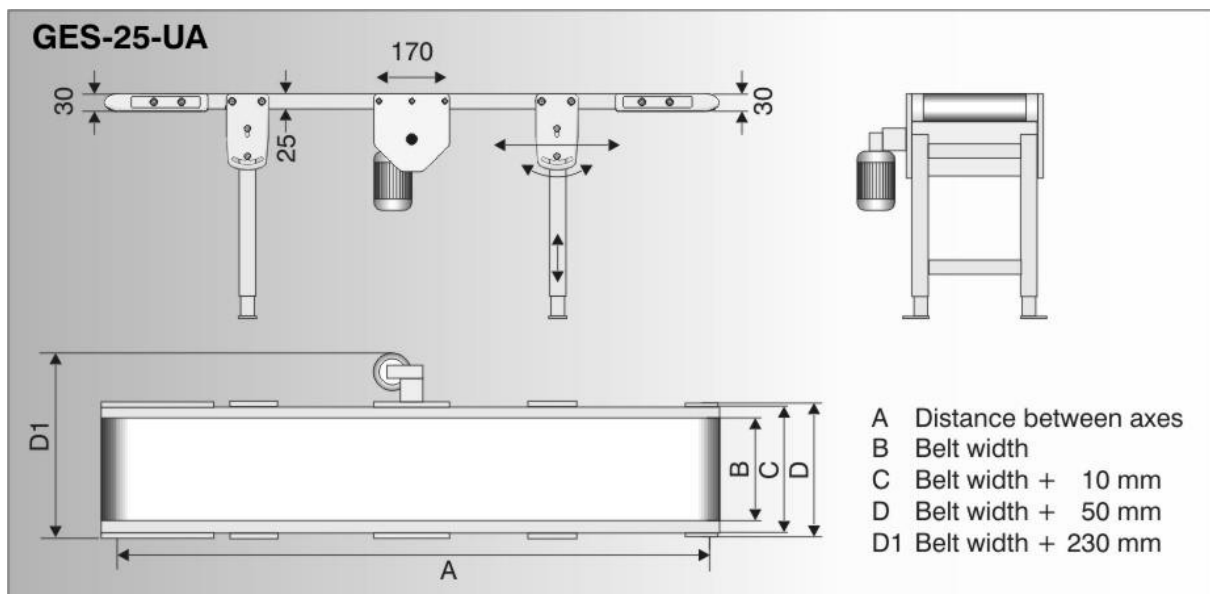

Figure 3-2: Basic dimensions GES-25-UA

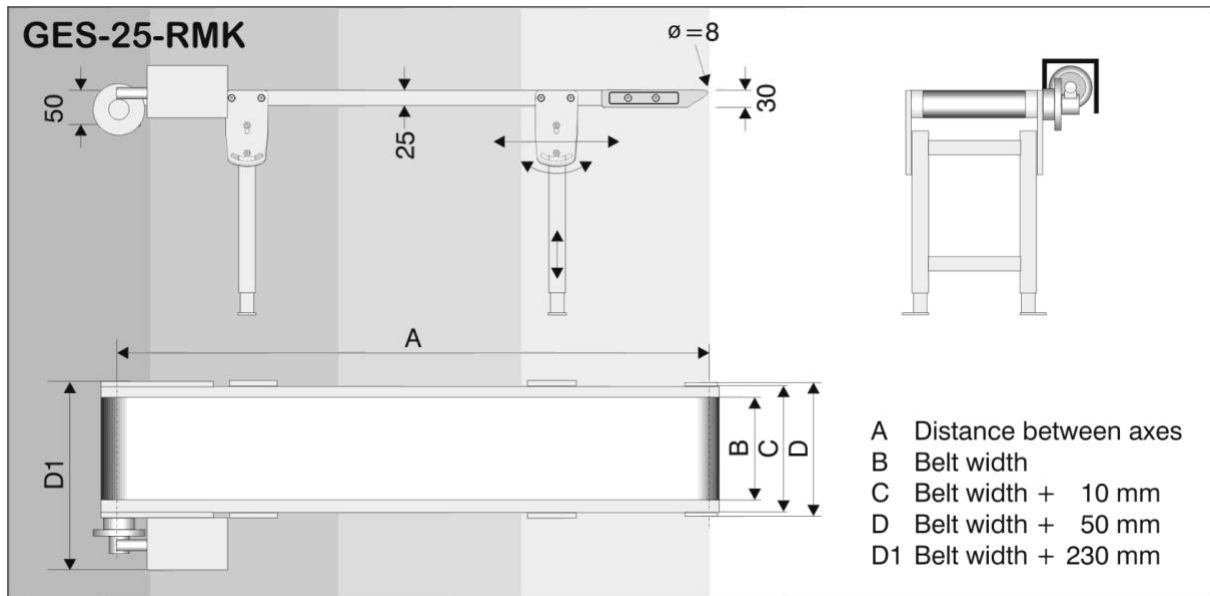

Figure 3-3: Basic dimensions GES-25-RMK

### 3.2 Belts

The following table contains the technical data of our most frequently used belt types. All of these can be equipped with cross slats and corrugated edges.

	Belt type					
	G1	G3 PVC	G3 PU blue	G3 PU white	G4 Mini	G4 Super
Load at elongation of 1% in N per mm width	8	8	10	8	10	8
Fabric type	Polyester	Polyester	Polyester, laterally stable	Polyester	Polyester	Polyester
No. of layers	2	2	2	2	2	2
Colour	grey	blue/green	blue	white	blue/green	blue/green
Material on carrying side	PVC	PVC	PU	PU	PVC	PVC
Surface on carrying side	fabric	smooth coated, slightly sticky	smooth matt	smooth matt	structured	structured
Thickness	1,5 mm	2,1 mm	2,3 mm	1,4 mm	2,7 mm	5,1 mm
Material on running side	fabric	fabric	fabric	fabric	fabric	fabric
Antistatic	no	yes	no	yes	no	no
Resistant against oil and grease	yes	partly	yes	yes	yes	no
FDA-approved	no	no	yes	yes	no	no
Temperature range	-10°C to +80°C	-10°C to +80°C	-25°C to +90°C	-25°C to +90°C	-10°C to +110°C	-10°C to +80°C
Minimum diameter of roller	30	30	30	30	30	60

Figure 3-4: Table on belt types



### 3.3 Motors

As a standard, our belt conveyors are equipped with three-phase AC motors and worm gears, protection class IP65. You can find dimensions and technical data of various standard motors below. Also special motors are available on request. Adjustment and maintenance of drive chains and clutches are described in section 4.

#### 3.3.1 Geared motor, type SN5FR:

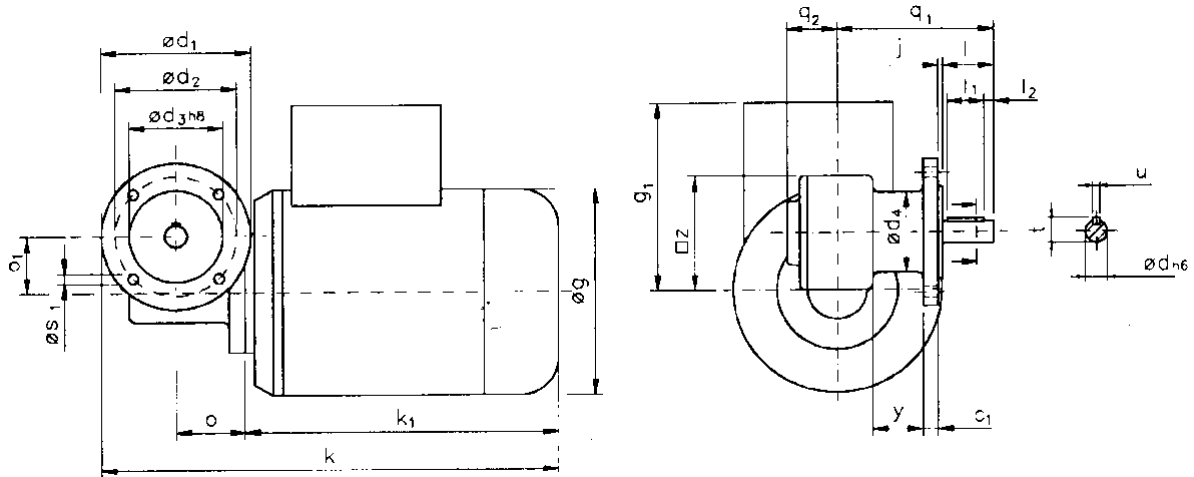

Mounting dimensions							Outline dimensions										Shaft dimensions					
$c_1$	$\varnothing d_1$	$\varnothing d_2$	$\varnothing d_3$	$\varnothing d_4$	$j$	$\varnothing s_1$	$g$	$g_1$	$k$	$k_1$	$o$	$\varnothing o_1$	$q$	$q_1$	$y$	$z$	$\varnothing d$	$l$	$l_1$	$l_2$	$t$	$u$
8	80	65	50	44	2,5	6,5	112	102	245	168	37	31	84	27	27	62	12	27,5	20	5	13,5	4

Gearbox data						
Motor data	90 Watt, 1400 rpm, weight 4,5Kg, 0,4Amps with 380V, IP65					
Gearbox ratio	7 : 1	10 : 1	15 : 1	20 : 1	30 : 1	55 : 1
Gearbox speed	200 rpm	140 rpm	93 rpm	70 rpm	47 rpm	25 rpm
Effective torque	3,5 Nm	4,6 Nm	6,5 Nm	8,1 Nm	10 Nm	13 Nm
max. permissible torque	10 Nm	10 Nm	11 Nm	10 Nm	10 Nm	10 Nm

3.3.2 Geared motor, type SN3F small flange:

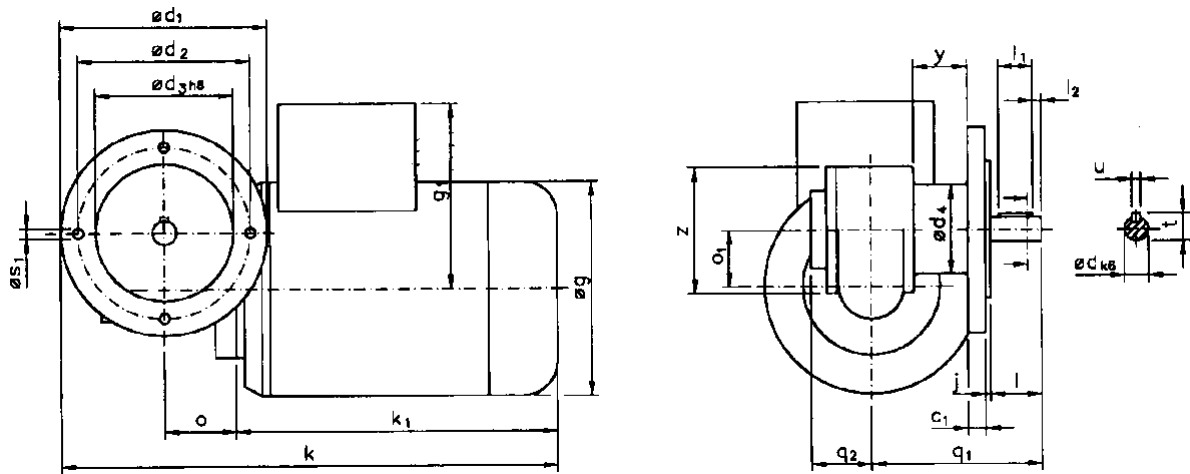

Mounting dimensions							Outline dimensions										Shaft dimensions						
c <sub>1</sub>	ød <sub>1</sub>	ød <sub>2</sub>	ød <sub>3</sub>	ød <sub>4</sub>	j	øS <sub>1</sub>		g	g <sub>1</sub>	k	k <sub>1</sub>	o	o <sub>1</sub>	q	q <sub>1</sub>	y	z	ød	l	l <sub>1</sub>	l <sub>2</sub>	t	u
10	80	65	50	52	3	6,5		125	108	288,5	187	41,5	33	99	35	30	74	14	30,0	20	5	16,0	5

Gearbox data						
Motor data	180 Watt, 1400 rpm, weight 6,1Kg, 0,7Amps with 380V, IP65					
Gearbox ratio	7 : 1	10 : 1	15 : 1	20 : 1	30 : 1	56 : 1
Gearbox speed	200 rpm	140 rpm	93 rpm	70 rpm	47 rpm	25 rpm
Effective torque	6,7 Nm	10 Nm	12 Nm	12 Nm	14 Nm	17 Nm
max. permissible torque	12 Nm	12 Nm	13 Nm	13 Nm	13 Nm	10 Nm

### 3.4 Electrical equipment

All our electrical equipment must only be exposed to liquids or dust within the regulations applicable to their protection type classification. Any contact to liquids or dust surpassing these limitations must be avoided.

#### 3.4.1 Frequency converter

All of our belt conveyors – provided a regulated belt speed is required – can be equipped with a frequency converter which controls a robust three-phase AC motor.

The converter GB-FU 180 is used with all motors up to 180 W. Motors with a power between 180 and 370 W are equipped with the converter GB-FU 370. Motors of higher performance than 370 W are fitted with a specially adapted frequency converter.



Figure 3-5: Frequency converter

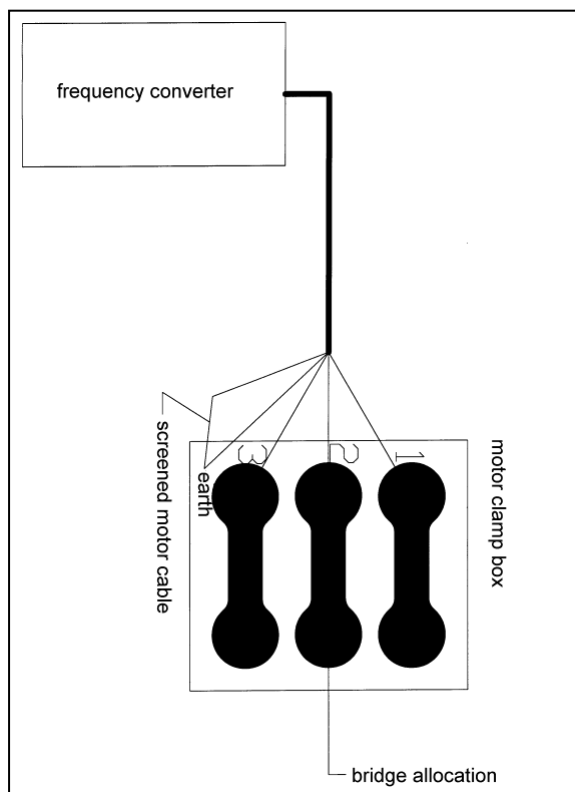

Figure 3-6: Connection of frequency converter to motor

All frequency converters are digital units which can be individually programmed. Each frequency converter also provides a motor overload protection. Thus a destruction of the motor by a jammed belt conveyor through mechanical faults is virtually impossible. In this case, the frequency converter cuts-off the current supply. Frequency converters are connected to 230V 50Hz AC. These units have a separate operating manual which will be provided with each delivery.

Additionally the frequency converter incorporates a stop switch in form of a red push button for fast cut off in case of an emergency. After the drop or loss of current the conveyor also doesn't restart by itself. A dedicated start button has to be pushed.

### 3.4.2 Motor overload switch

All of our belt conveyors – provided a constant belt speed is required – can be equipped with a motor overload switch which controls a robust three-phase AC motor.



Figure 3-7: Motor overload switch

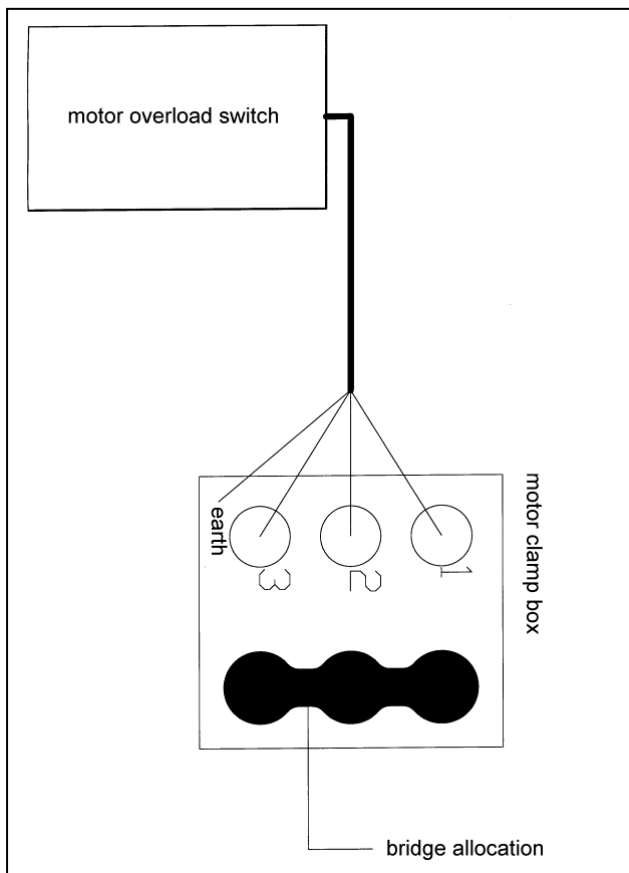

Figure 3-8: Connection of overload switch to motor

The motor overload switch protects the motor from overload. Thus a destruction of the motor by a jammed conveyor belt through mechanical faults is virtually impossible. In this case, the motor overload switch cuts-off the current supply. In addition, the motor overload switch is equipped with an emergency-stop-switch designed as a snap-switch providing a quick shut-down of the belt conveyor. The motor overload switch is connected to 380V 50Hz three-phase current.

**3.4.3 Emergency-stop-switch**

In addition, all belt conveyors can be equipped with one or more mushroom shaped emergency-stop-switches.

The emergency-stop-switch is connected in series between power source and conveyor belt, so that actuating one of the switches shuts down the complete belt conveyor.

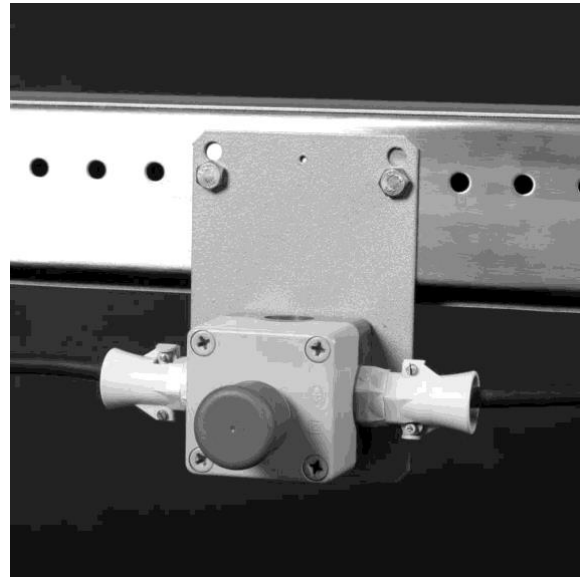

Figure 3-9: Emergency-stop-switch

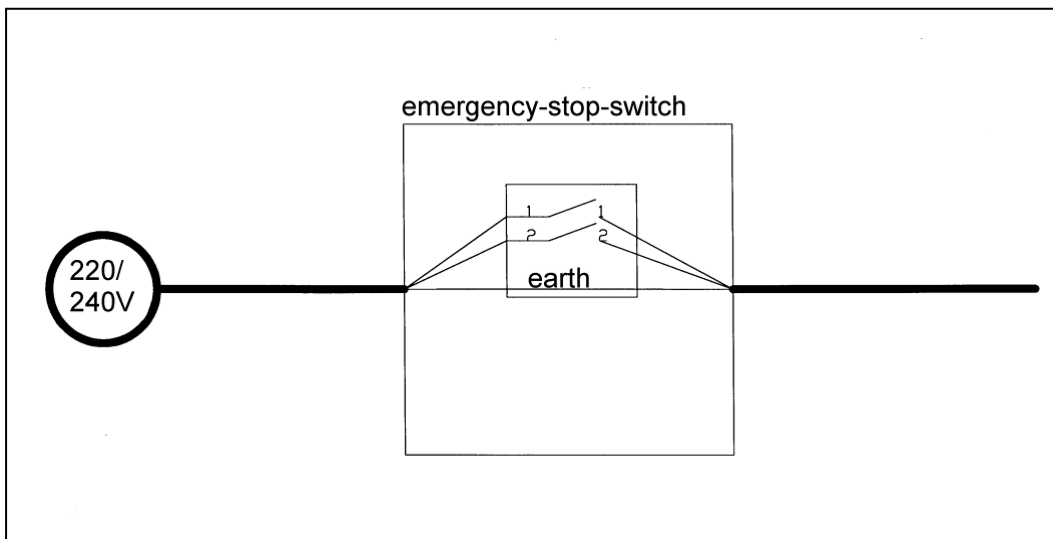

Figure 3-11: Connection of emergency-stop-switch to 230V 50Hz

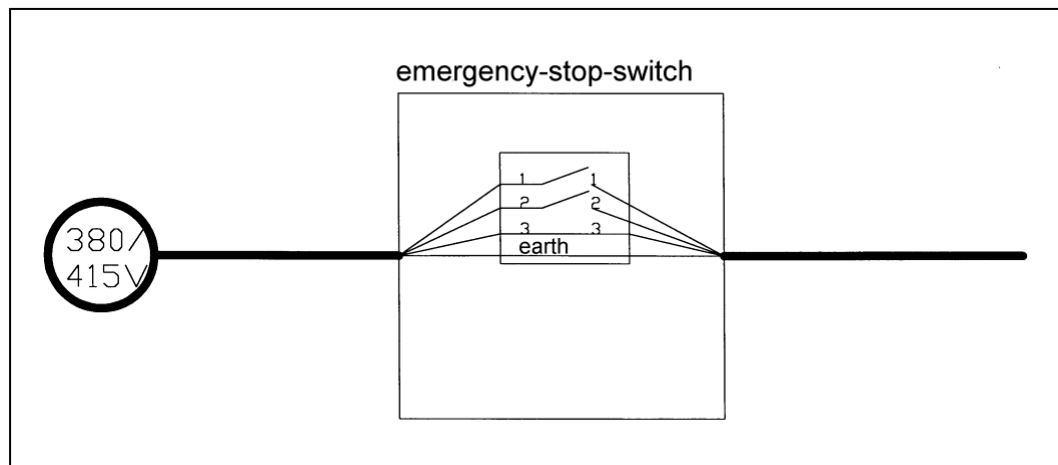

Figure 3-10: Connection of emergency-stop-switch to 380V 50Hz

## 4 Adjustments

Whenever adjustments are carried out, it has to be made sure that all covers or holders that had to be removed are reinstalled after the service and before the conveyors are used again.

### 4.1 Drives

#### 4.1.1 Drive underneath the belt

None of our stainless steel conveyors is designed for a position of the motor hanging underneath the belt. Such a position cannot be recommended due to the expected amount of contamination.

#### 4.1.2 Side mounted drive

If the drive motor is installed at the side of the conveyor belt, a correct adjustment of the clutch must be ensured.

As shown in the opposite figure, the motor (A) must be removed by undoing the fixing screws (B) to be able to adjust the clutch.

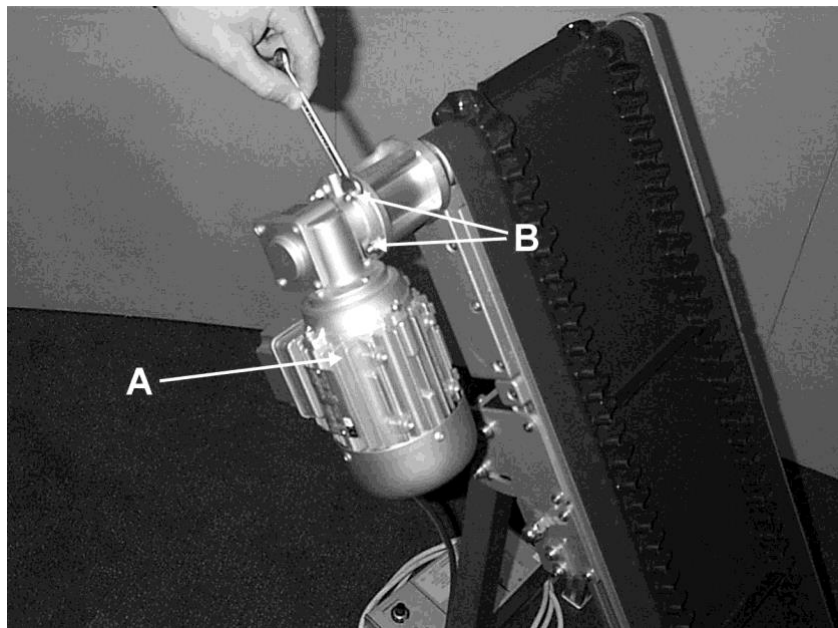

Figure 4-1: Dismounting side motor

If the clutch housing (E) is positioned between motor (A) and flange (F), then the distance between the clutch wheels (C) of the motor and the drive roller (D) must be approximately 15 mm, see the opposite figure. After adjustment of distance, the clutch sleeve (not shown in the figure) must be put on again on the clutch wheel (C) fitted to the drive roller (D). The fixing screws (B) must be retightened.

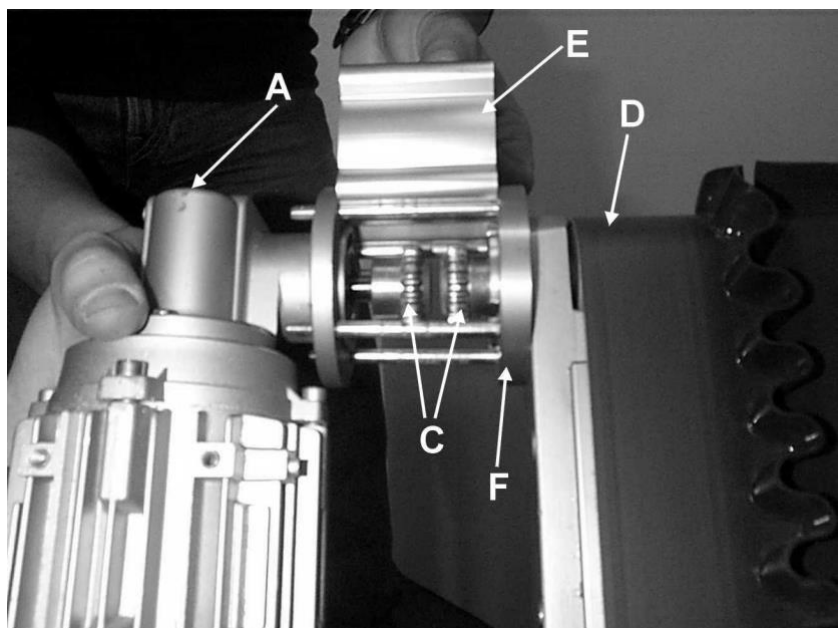

Figure 4-2: Adjustment of clutch play

If the motor is installed at the side of the conveyor belt, it can be mounted at 90° angular intervals around the flange, see the opposite figure.

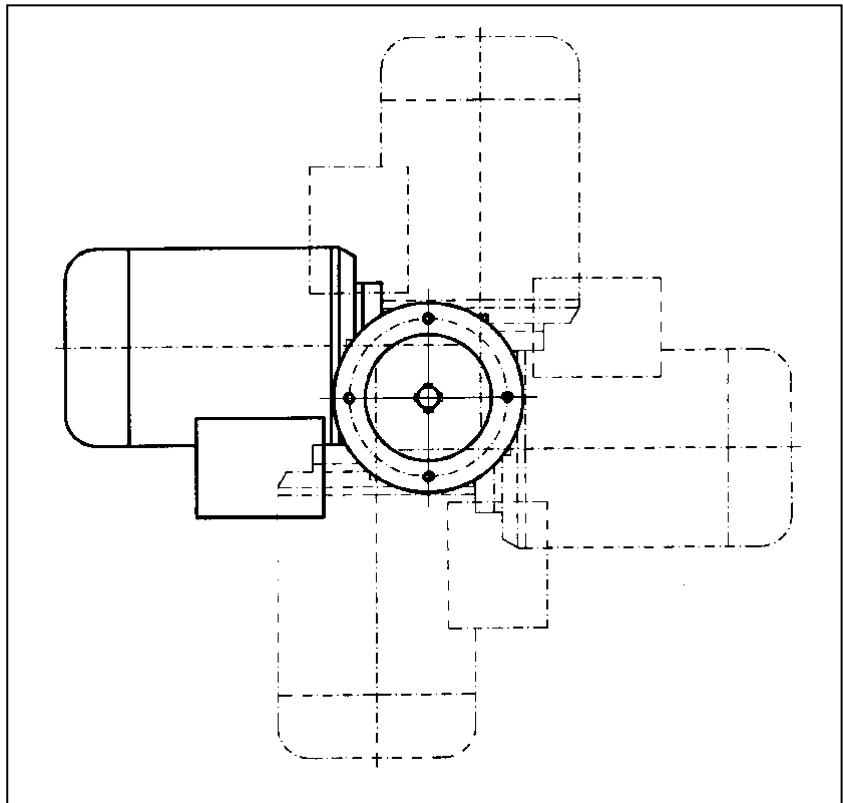

Figure 4-3: Rotated installation positions of the motor

## 4.2 Belt alignment

The belt reacts to a repositioning of the brackets holding the roller as it is shown in the opposite figure.

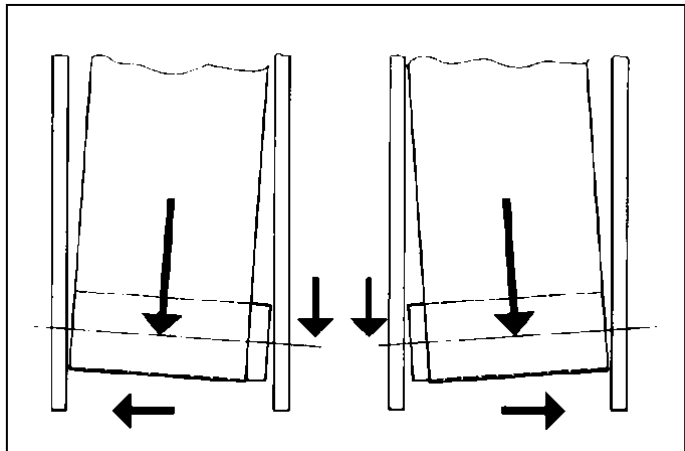

Figure 4-4: Belt reaction to different bracket positions

With longer belt conveyors, supporting rollers are used on the underside of the conveyor to hold the belt up on its way back. These rollers can also be used for tracking of the belt. The following figure shows the reaction of the belt tracking when the holding plates of the supporting rollers are shifted.

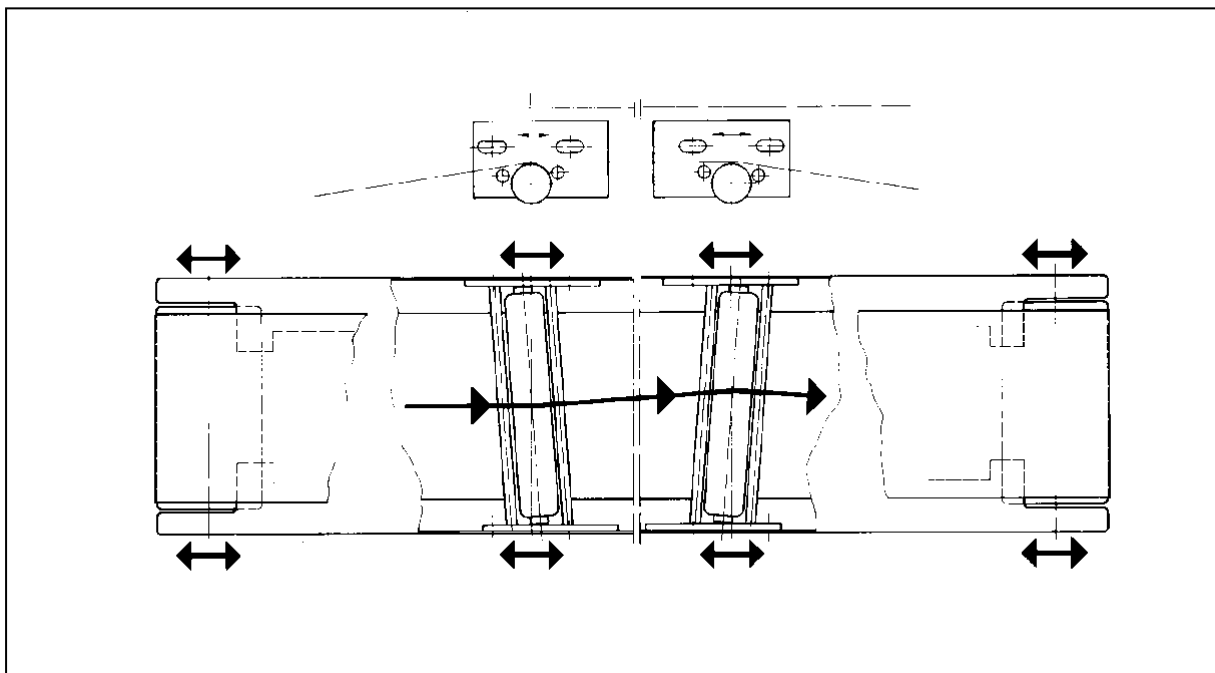

Figure 4-5: Tracking of belt using supporting rollers



#### 4.2.1 Deflecting roller:

To align the belt track on the deflecting roller, loosen slightly the fixing screws (A) of the head piece (B), see the opposite figure. The fixing screw (C) of the positioning block (D) must be tightened firmly. The head unit (B) can then be moved in relation to the frame (E) by turning the adjustment screw (F). After adjustment, the fixing screws (A) must be firmly retightened.

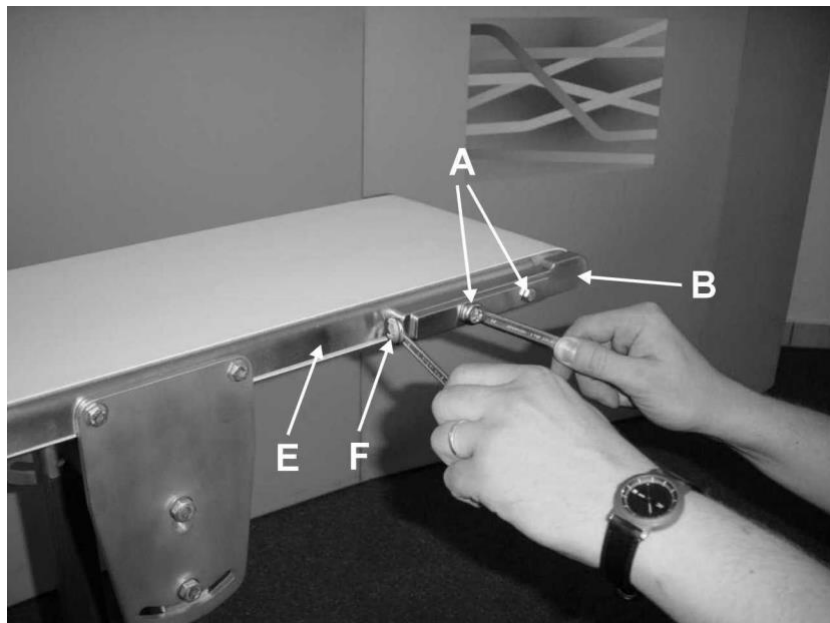

Figure 4-6: Belt alignment at deflecting roller

#### 4.2.2 Drive roller:

To align the belt track on the drive roller, loosen slightly the fixing screws (A) of the head piece (B), see the opposite figure. The fixing screw (C) of the positioning block (D) must be tightened firmly. The head unit (B) can then be moved relative to the frame (E) by turning the adjustment screw (F). After adjustment, the fixing screws (A) must be firmly retightened.

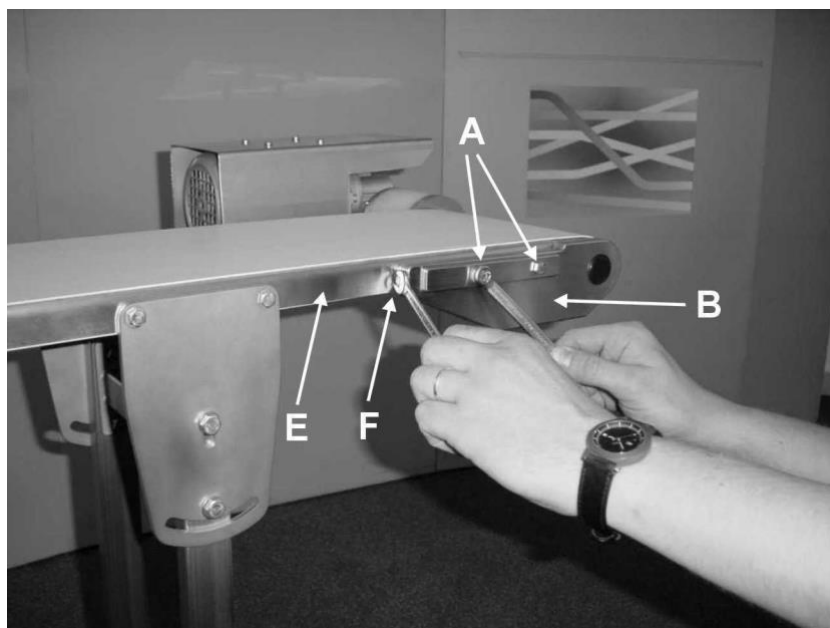

Figure 4-7: Belt alignment at drive roller

#### 4.2.3 Knife edge

The knife edge of the GES-25-MK provides the same adjustment features as the the drive and deflecting rollers of the GES-25.

#### 4.2.4 Lower drive of GES-25-UA

To align the belt track in the lower drive of GES-25-UA, you first have to remove the holding screws (A) of the casing cover (B), as shown in the figure on the right. The casing cover (B) can then be demounted. There is one cover on each side of the lower drive. The belt track should first be adjusted on the side of the belt's entry into the lower drive. Only then can the belt track also be readjusted on the side of the belt's exit.

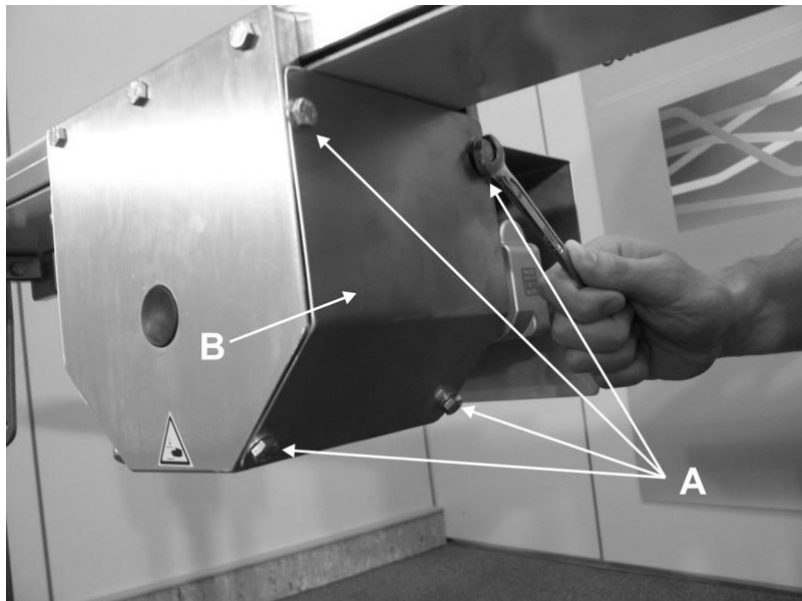

Figure 4-8 : Removal of lower drive casing cover

In order to align the course of the belt (E), you can then use the adjusting screws (C) located in the holding screws' (A) threaded holes, as shown in the figure on the right. The position of the roller (D) should be adjusted in such a way that belt (E) runs more or less centrally under frame (F).

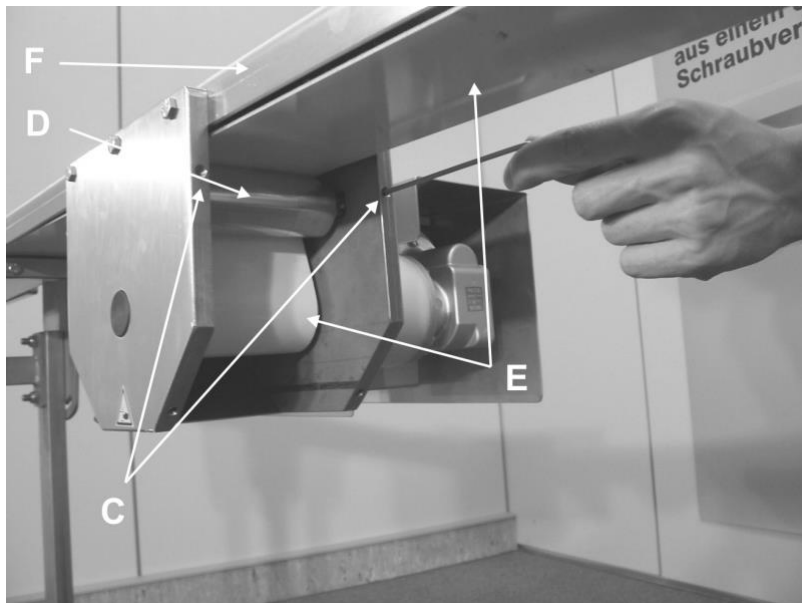

Figure 4-9 : Adjustment of lower drive belt track

### 4.3 Supports

#### 4.3.1 Protection against tip-over of flat belt conveyors

Conveyors that are equipped with supports designed for a bolted connection to the ground should always be secured by such a joint.

Some of our support models come with security casters with brakes. With these the conveyor can easily be used at different locations. But these supports are less stable than those without wheels. Therefore the transport of the conveyor to a new location using a ramp or going up an inclination has to be additionally secured, because the conveyor might tip over.

While the conveyor is in use the supports should always be oriented as much towards the ends of the conveyor as possible. For a distance of 400mm between the end of the conveyor and the centre of the support (distance a) the following diagram shows the maximum weight admitted on the conveyor end for a known width and length of the conveyor.

**Maximum weight at end of belt for GES-25 with supports on wheels**

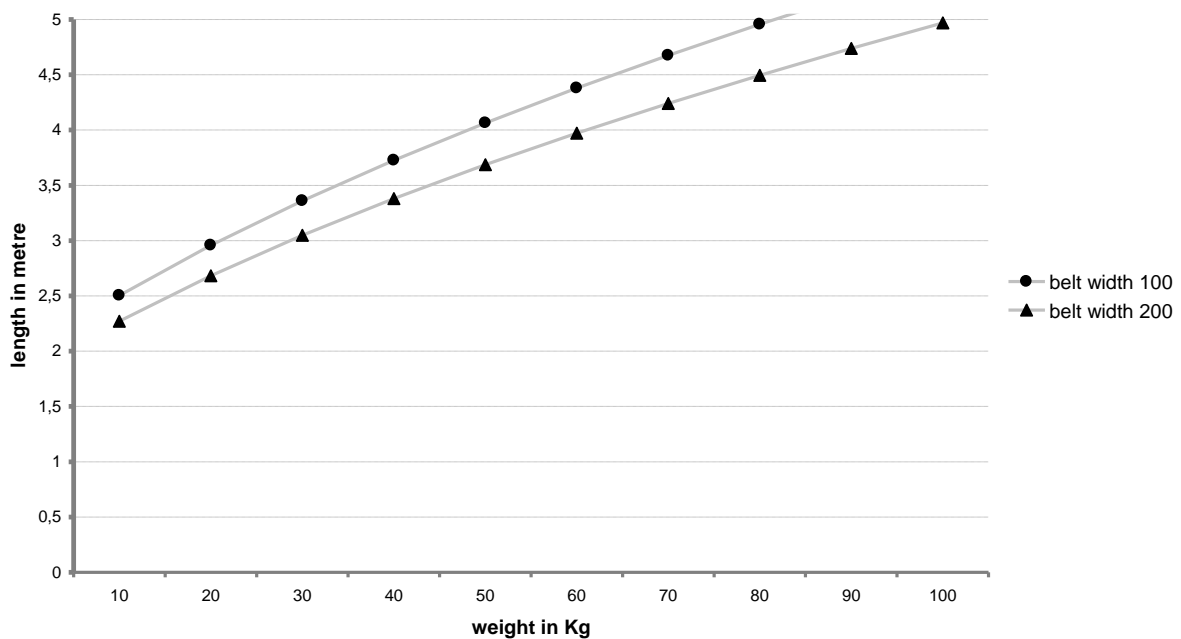

Figure 4-10: Maximum weight at end of conveyor with supports on wheels

#### 4.3.2 Two-legged aluminium support

The aluminium double upright is continuously adjustable in height. At first the fixing screws (A) of the cross bar (B) must be loosened, see the opposite figure. Then the upright insert (C) can be pulled out of the tube (D). The standard adjustment range is 200mm. After adjustment, retighten firmly the two fixing screws (A).

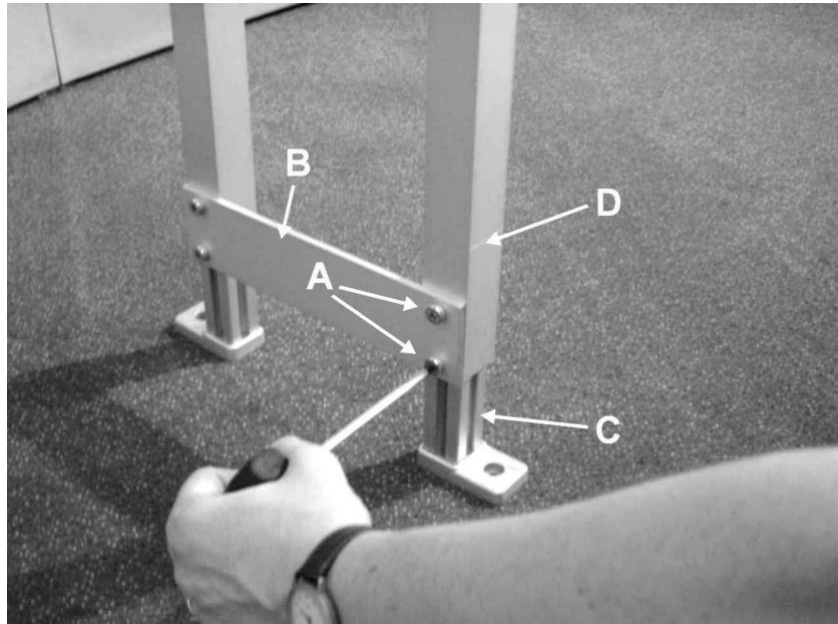

Figure 4-11: Two-legged aluminium support, height adjustment

The aluminium double upright can also be continuously adjusted in its inclination. At first the fixing screws (A) must be loosened on the upright plate (B), like in the opposite figure. Then the head of the upright can be pivoted in the guidance (C) of the plates (B) from +30° up to -30°. In vertical position, the head of the upright snaps into the lock-in position (D) and is consequently secured against unintended pivoting. The aluminium double upright is also available with plates as a pivoting version ranging from horizontal up to vertical position.

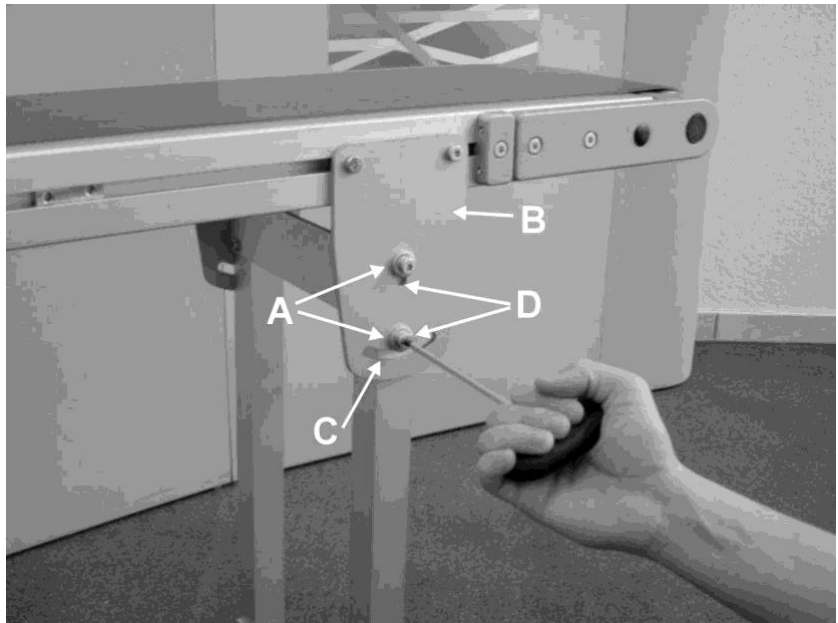

Figure 4-12: Two-legged aluminium support, inclination adjustment

#### 4.3.3 Two-legged aluminium support, short version

A shortened variant of the aluminium double upright is equipped with fixed castors. It is also height-adjustable as described in section 4.3.2, however, the adjustment range is only 50 mm and is intended to level out ground irregularities. The adjustment of inclination is the same as described in section 4.3.2.

#### 4.3.4 Two-legged steel support

The steel double upright can be continuously adjusted in height. At first the fixing screws (A) of the cross bar (B) must be loosened, as shown in the opposite figure. Then the insert (C) can be pulled out of the upright tube (D). An adjustment range of 200mm is available as a standard. After adjustment, the two fixing screws (A) must be firmly retightened.

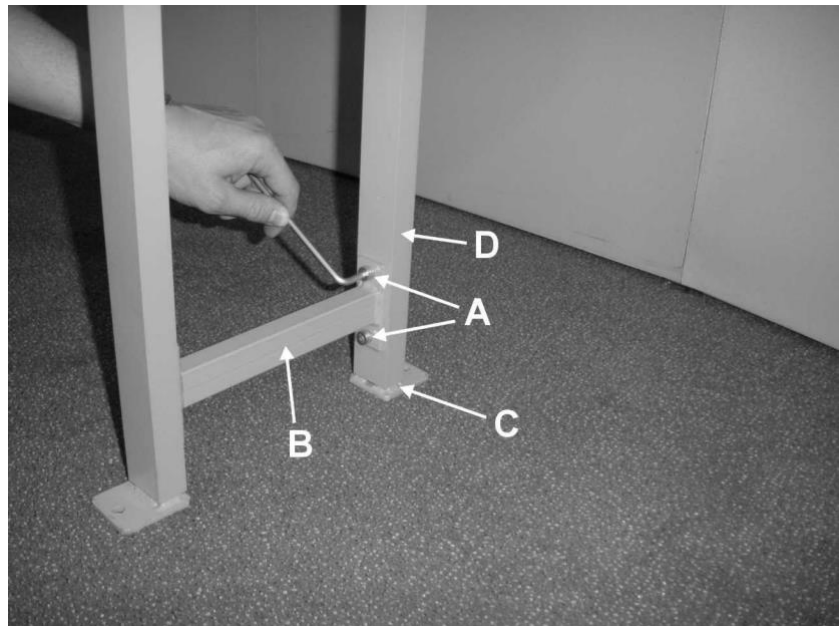

Figure 4-13: Two-legged steel support, height adjustment

The steel double upright can also be continuously adjusted in its inclination. At first the fixing screws (A) must be loosened on the upright plate (B), like in the opposite figure. Then the head of the upright can be pivoted in the guides (C) of the plates (B) from +30° up to -30°. In vertical position, the head of the upright snaps into the lock-in position (D) and is consequently secured against unintended pivoting. The steel double upright is also available with plates as a pivoting version ranging from horizontal up to vertical position.

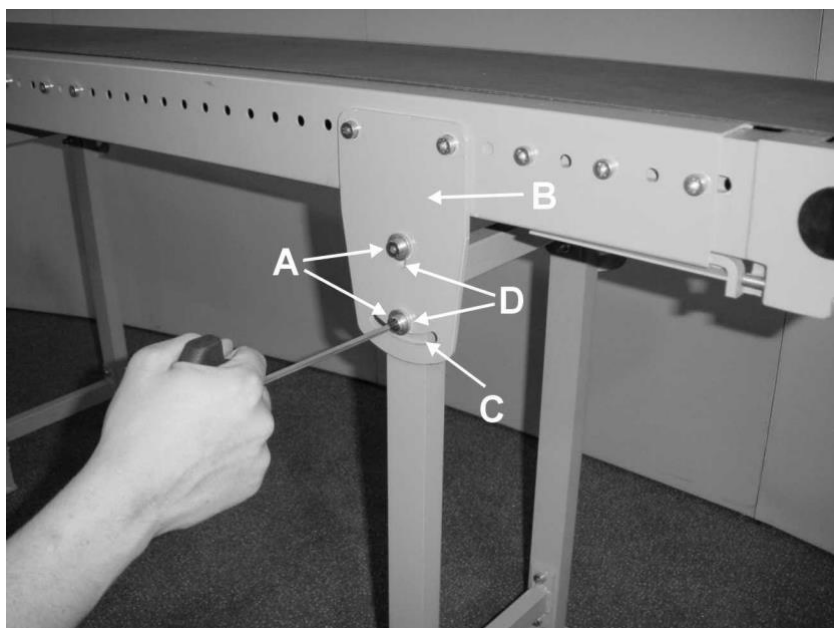

Figure 4-14: Two-legged steel support, inclination adjustment

#### 4.3.5 Two-legged steel support, short version

A shortened variant of the steel double upright is equipped with fixed castors. It is also height-adjustable as described in section 4.3.4, however, the adjustment range is only 50 mm and is intended to level out ground irregularities. The adjustment of inclination is the same as described in section 4.3.4.

#### 4.3.6 Short steel support held from side

To adjust the height of a short steel support held from the side, first loosen the fixing screws (A) on the side plate (B), like in the opposite figure. Then the short support (C) can be adjusted within the guide (B). After adjustment, retighten the two fixing screws (A) firmly.

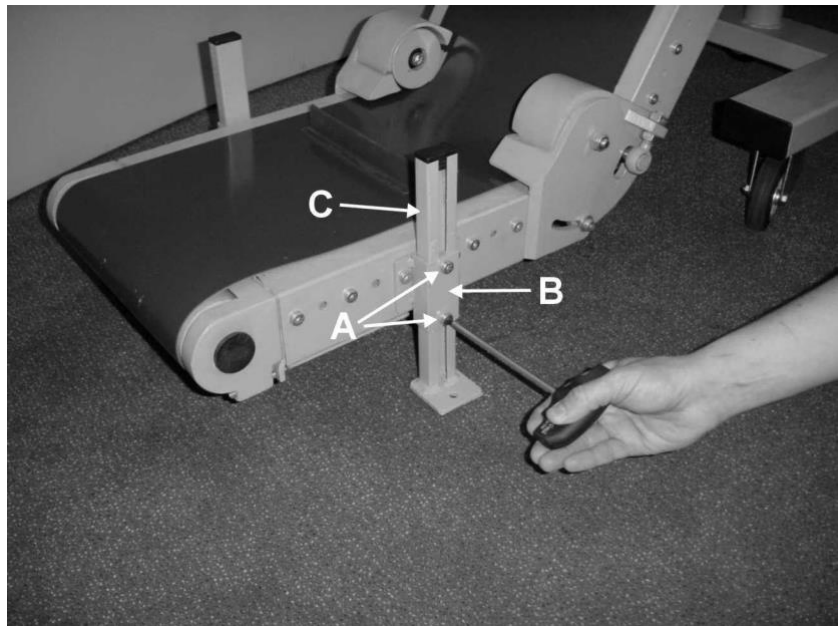

Figure 4-15: Short steel support held from side, height adjustment

#### 4.3.7 Two-legged stainless steel support

The two-legged stainless steel support provides the same adjustment features as the two-legged steel support. It also exists in the same variants, i.e. the short version with fixed casters and the short version held from the side.

#### 4.3.8 Single-legged steel support with aluminium base plate

The single-legged steel support with aluminium base plate can be continuously adjusted in height. First loosen the fixing screw (A) on the adjustment ring (B), see the opposite figure. The forked pipe (C) can then be pulled out of the standpipe (D). The adjustment range is 200mm. After adjustment, retighten the fixing screw (A) firmly.

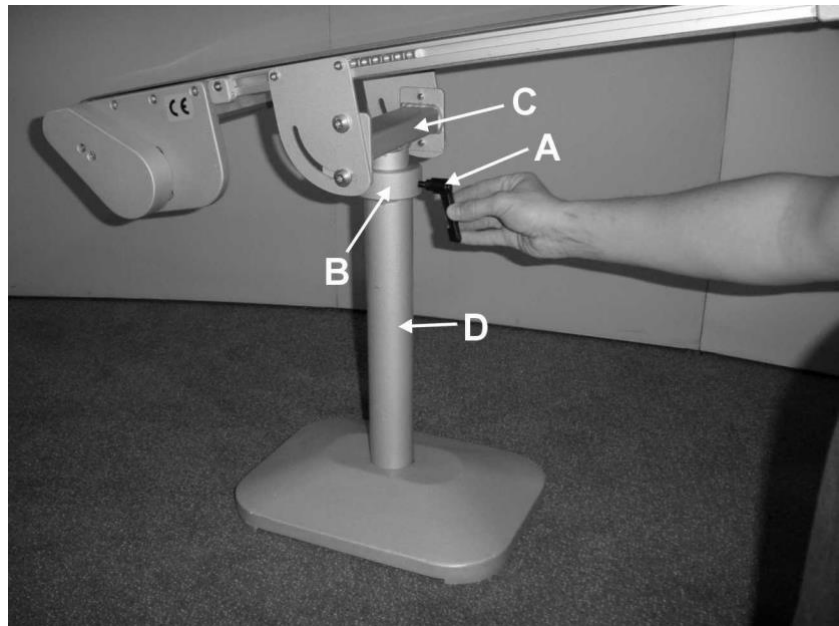

Figure 4-16: Single-legged steel support with aluminium base plate, height adjustment

The single upright made of steel can also be continuously adjusted in its inclination. At first the fixing screws (A) must be loosened on the upright plate (B), like in the opposite figure. Then the head of the upright can be pivoted in the guides (C) of the plates (B) from horizontal to vertical position.



Figure 4-17: Single-legged steel support with aluminium base plate, inclination adjustment

#### 4.3.9 Steel H-shaped single-legged support

The steel H-shaped single-legged support provides the same adjustment features as the steel single upright with aluminium base plate.

#### 4.3.10 Steel H-shaped single-legged support with castors

The steel H-shaped single-legged support with castors provides the same adjustment features as the H-single upright made of steel. In addition, it is equipped with Total-Stop-Safety castors as shown in the opposite figure. When the brake is actuated, the upright is secured against unintentional movement.

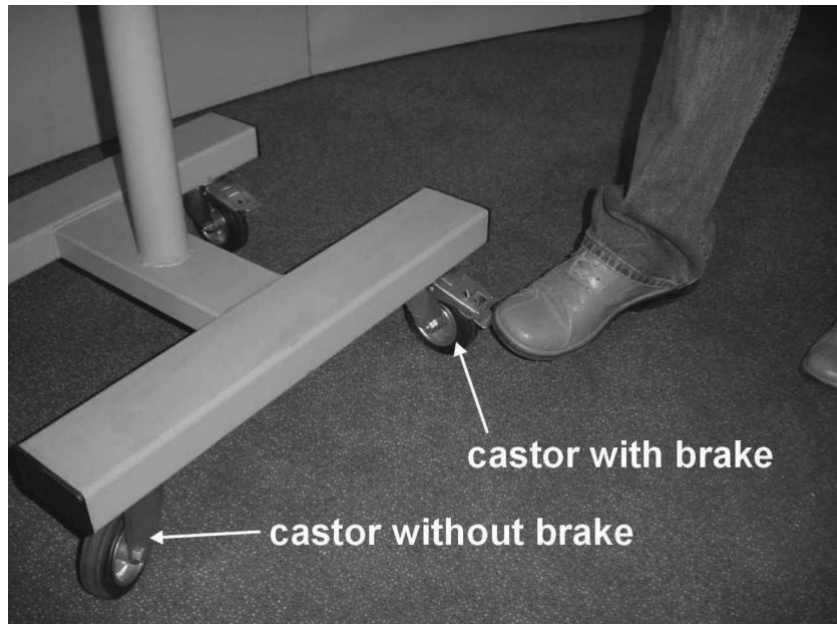

Figure 4-18: Steel H-shaped single-legged support, brake

#### 4.3.11 Stainless steel H-shaped single-legged support

The stainless steel H-shaped single-legged support provides the same adjustment features as its steel version described under 4.3.9.

#### 4.3.12 Stainless steel H-shaped single-legged support with castors

The stainless steel H-shaped single-legged support with castors provides the same adjustment features as its steel version described under 4.3.10.

## 5 Spare parts

All components of the belt conveyor model GES-25 are shown in the following exploded views. Any part on your conveyor, that is not shown in these views, is a specially adapted part. We keep a full record of all special parts in our production files. Please contact us directly if you need any help on one of these parts.



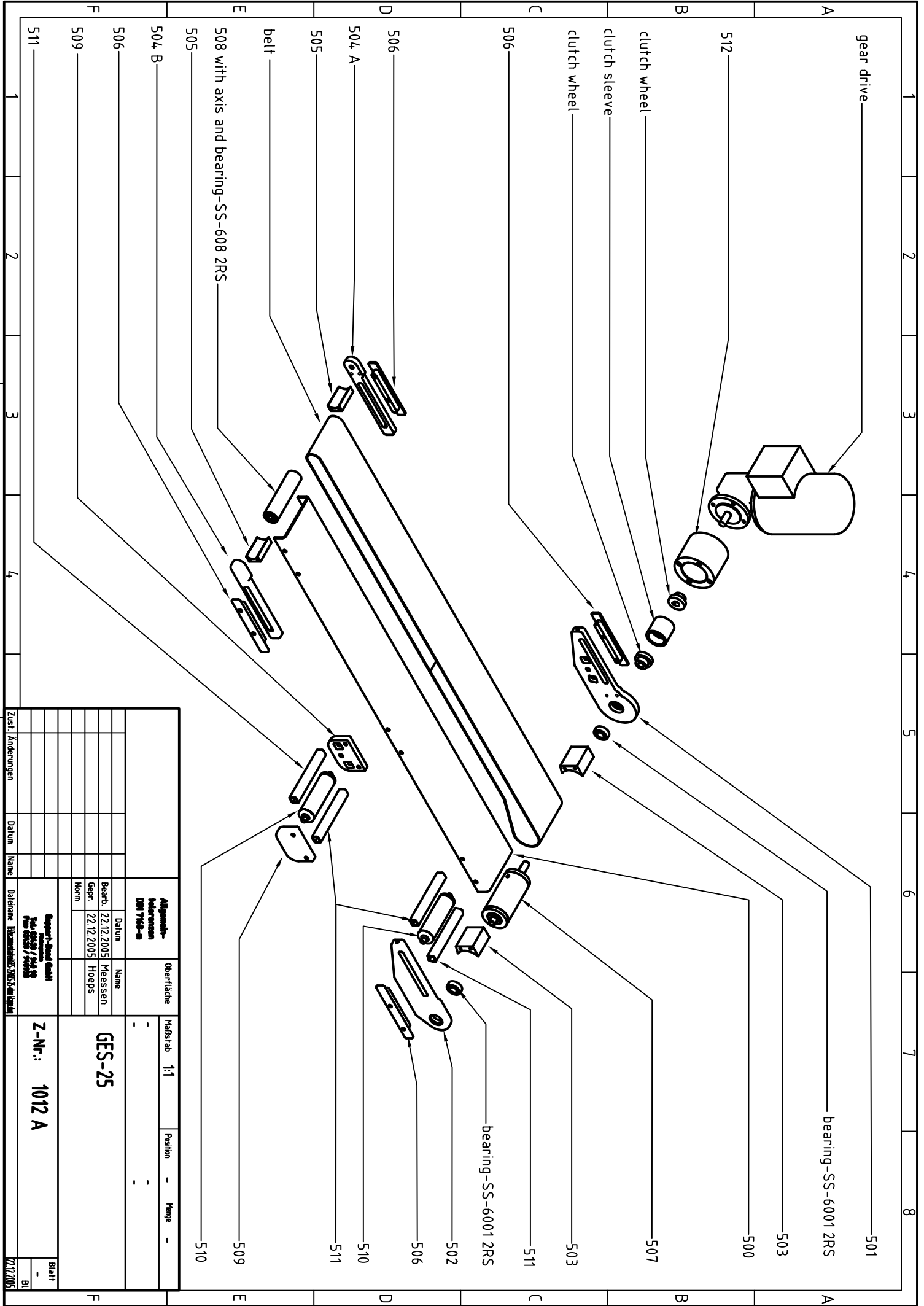

General Information	Surfaces	Scale	Position	Quantity																						
<table border="1"> <tr> <td colspan="2">Allgemein-</td> <td colspan="2">Oberfläche</td> </tr> <tr> <td colspan="2">Information</td> <td colspan="2">-</td> </tr> <tr> <td colspan="2">DIN 7845-4</td> <td colspan="2">-</td> </tr> </table>	Allgemein-		Oberfläche		Information		-		DIN 7845-4		-		<table border="1"> <tr> <td>Datum</td> <td>Name</td> </tr> <tr> <td>22.12.2005</td> <td>Messsen</td> </tr> <tr> <td>22.12.2005</td> <td>Hoeps</td> </tr> <tr> <td>Norm</td> <td></td> </tr> </table>	Datum	Name	22.12.2005	Messsen	22.12.2005	Hoeps	Norm		Maßstab	1:1	-	-	-
Allgemein-		Oberfläche																								
Information		-																								
DIN 7845-4		-																								
Datum	Name																									
22.12.2005	Messsen																									
22.12.2005	Hoeps																									
Norm																										
Bearb. 22.12.2005 Gepr. 22.12.2005 Norm		<b>GES-25</b>																								
Z-Nr.: 1012 A																										
Zustand Änderungen																										
Datum Name																										
Diehtane Bismuth-S-515-Schlicht																										
Eigent-stand Datum 20.09.05 / 20.09.05 20.09.05 / 20.09.05																										
Blatt -																										
Blatt 22/2005																										

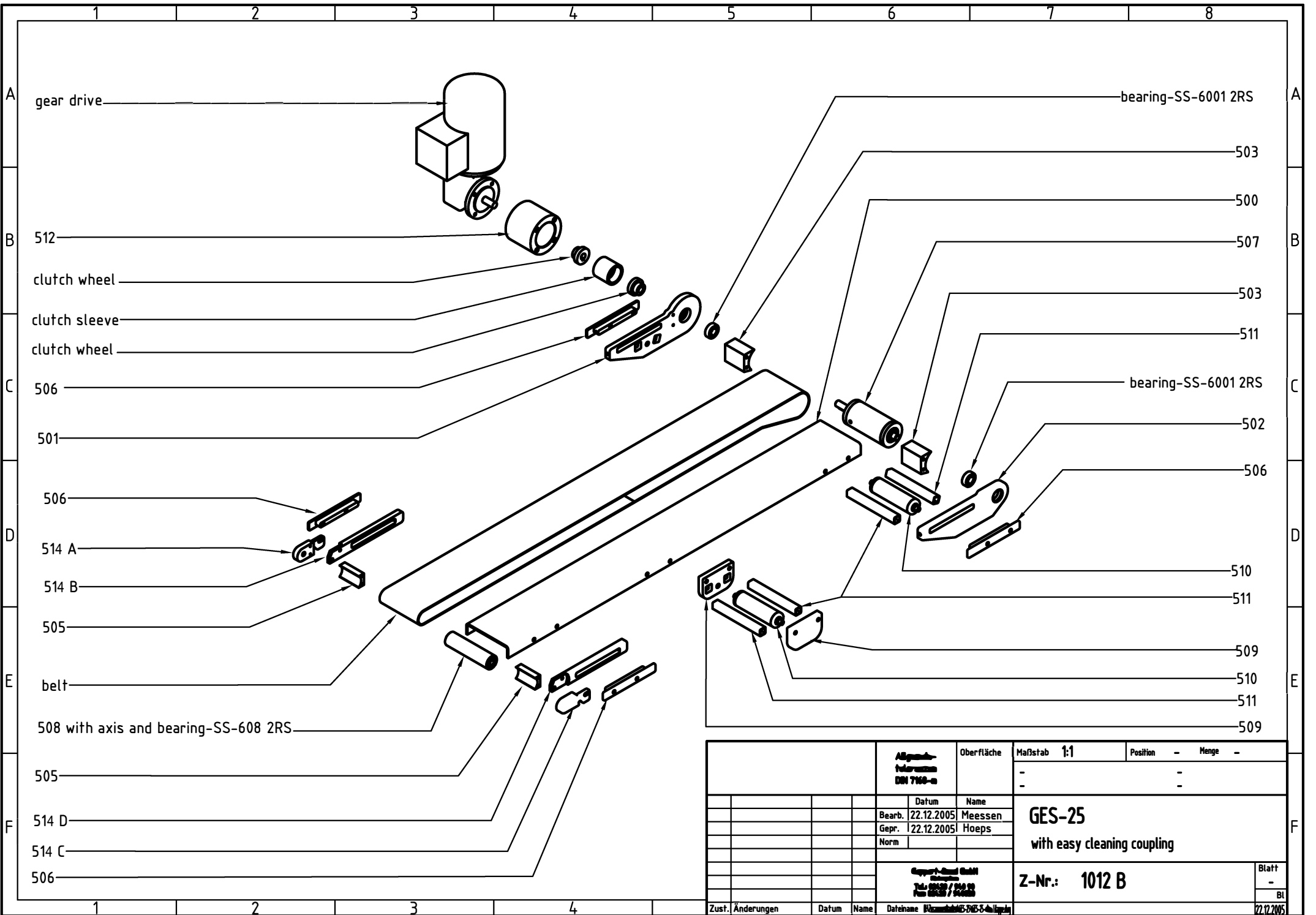

Allgemeine Informationen DIN 7169-m		Oberfläche	Maßstab 1:1	Position -	Menge -
Datum		Name	-		
Bearb.	22.12.2005	Meessen	-		
Gepr.	22.12.2005	Hoeps	-		
Norm			-		
Gesamt-Blatt		GES-25			Blatt
Teil-Nr. / Blatt-Nr.		with easy cleaning coupling			-
		Z-Nr.: 1012 B			Bl
					22.12.2005
Zust.	Änderungen	Datum	Name	Dateiname	Blatt-Nr.

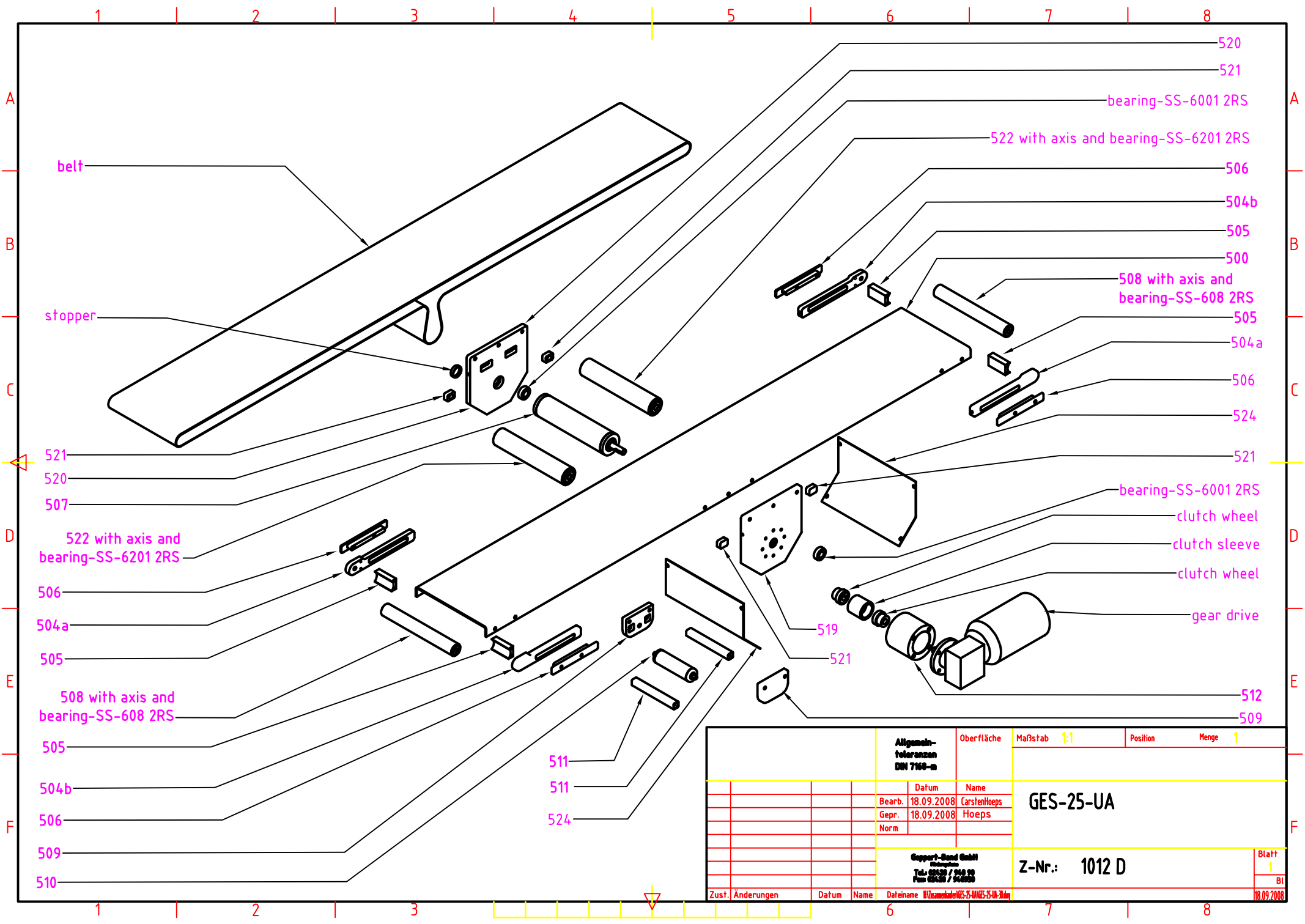

Allgemeintoleranzen DIN 7180-m		Oberfläche	Maßstab 1:1	Position	Menge 1
Datum		Name	GES-25-UA		
Bearb.	18.09.2008	CarstenHoeps			
Gepr.	18.09.2008	Hoeps			
Norm					
Gespart-Hand GmbH Rheinland Tel: 06430 / 500 99 Fax: 06430 / 500 99		Z-Nr.: 1012 D		Blatt 1	
Zust.	Änderungen	Datum	Name	Dateiname	18.09.2008

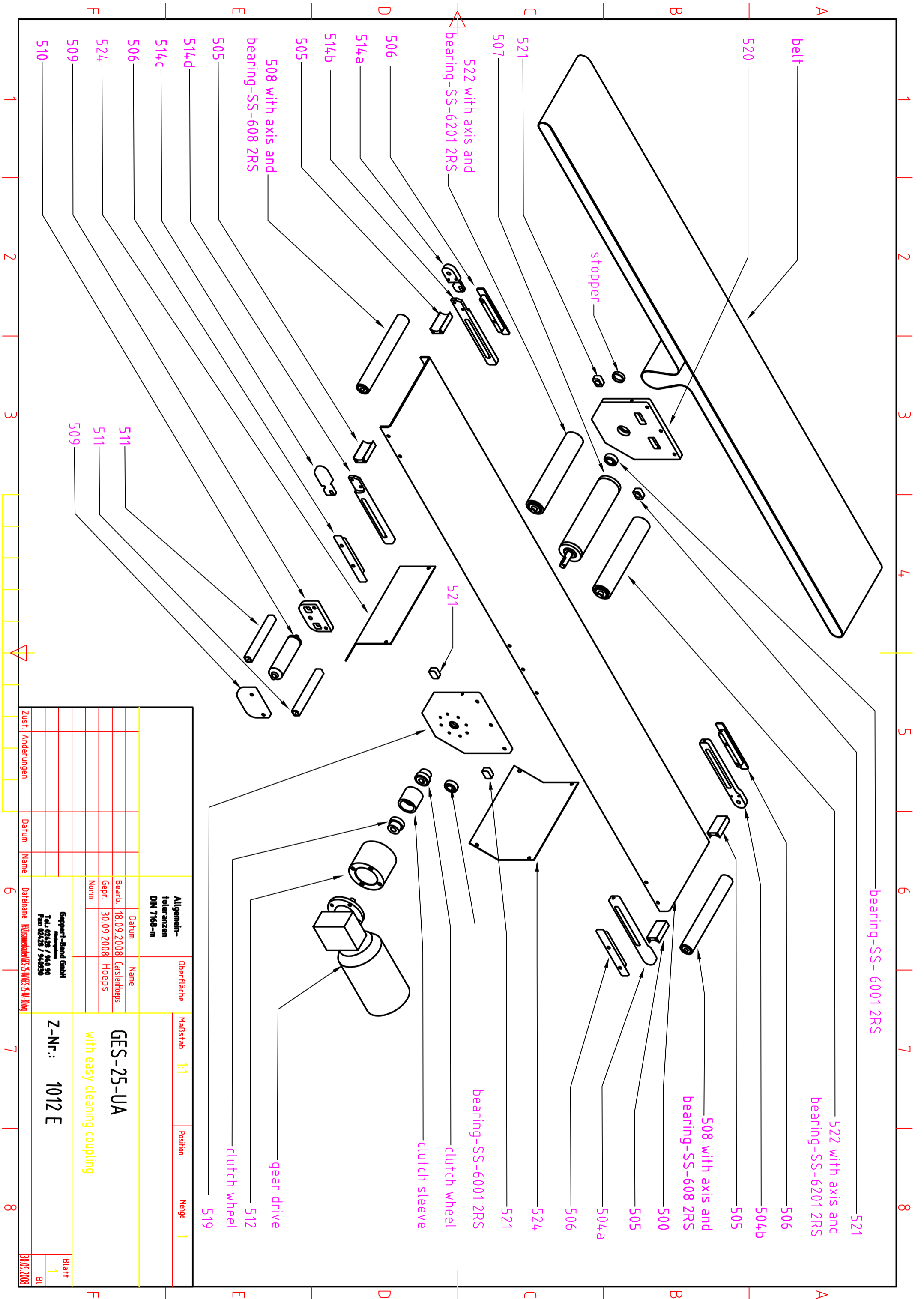

General tolerances DIN 7168-m	Surface	Scale	Position	Quantity								
<table border="1"> <tr> <th>Datum</th> <th>Name</th> </tr> <tr> <td>18.09.2008</td> <td>Carsten Hoeps</td> </tr> <tr> <td>30.09.2008</td> <td>Hoeps</td> </tr> <tr> <td>Norm</td> <td></td> </tr> </table>		Datum	Name	18.09.2008	Carsten Hoeps	30.09.2008	Hoeps	Norm		<p><b>GES-25-UA</b> with easy cleaning coupling</p>		
Datum	Name											
18.09.2008	Carsten Hoeps											
30.09.2008	Hoeps											
Norm												
Z-Nr.: 1012 E				Blatt 1								
Zust. Änderungen				B1								

Geppert-Band GmbH  
 Hohenheim  
 Tel.: 07528 / 340 90  
 Fax: 07528 / 340 930

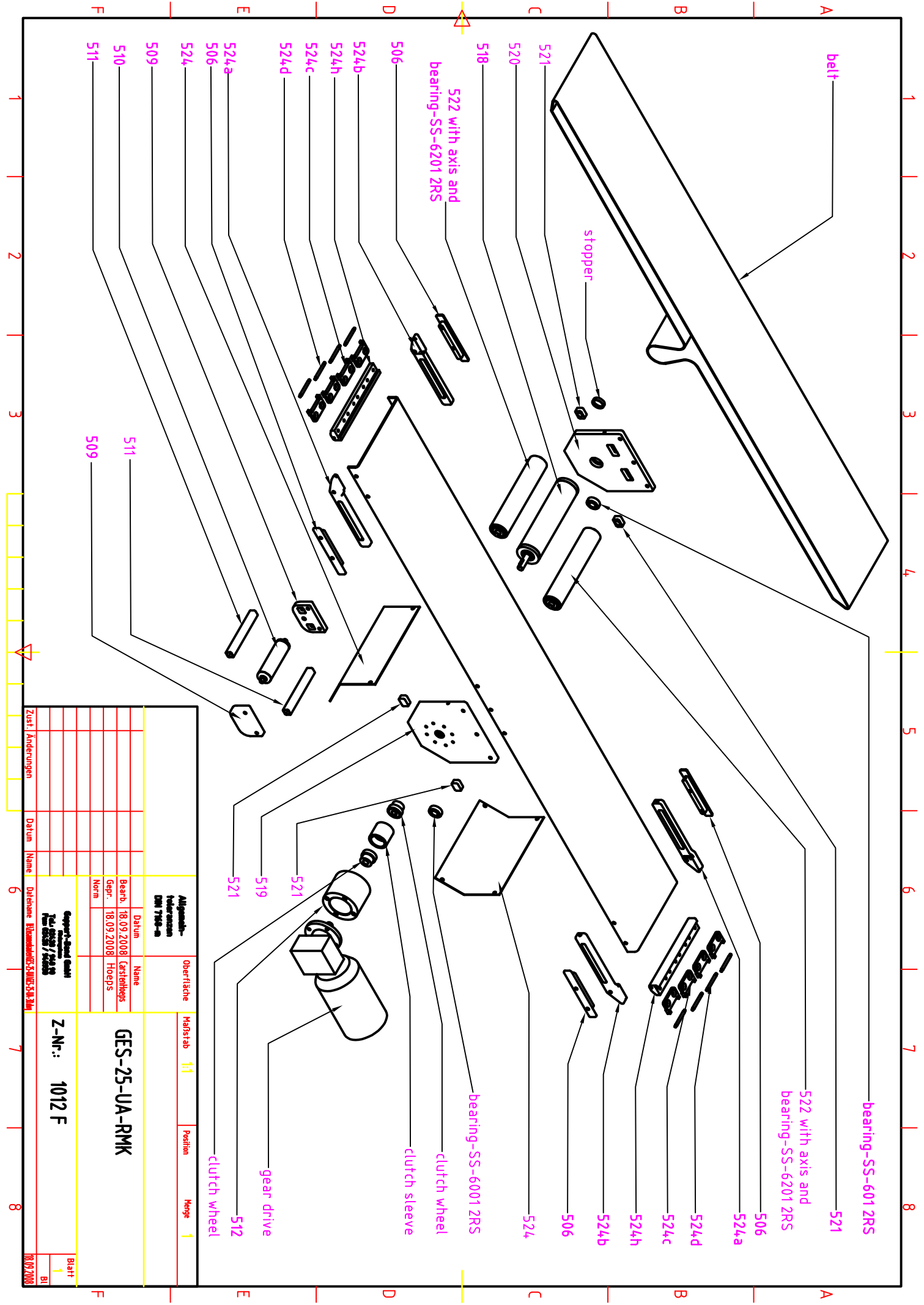

Zust./Anderungen	Datum	Name	Datenname	Ergebr.-Stand	Z-Nr.	Blatt
				Support-Standard	1012 F	1
				Technische Zeichnung		81
				Rev. 00208 / Rev. 003		

Algemein-Informationen DW 7043-a	Oberfläche	Maßstab	Position	Menge
Bearb.: 18.09.2008 Gepr.: 18.09.2008 Norm:	Name: Casterlöhns Dateiname: Hoeps	1:1		1
<b>GES-25-UA-RMK</b>				

Datum: 18.09.2008	Blatt: 1
Datum: 18.09.2008	Blatt: 81



Zust. Änderungen		Datum		Name		Dateiname: Bismuth\GES-25\GES-25.dwg	
Allgemein- Informationen DN 7948-01				Oberfläche		Maßstab	1:1
Datum				Name		Position	-
Bearb. 12.22.2005				Messsen		Menge	-
Gepr. 25.01.2006				Hoeps			
Norm							
<b>Copyright-Gezeichnet durch:</b> TWA 00003 / 0001 00 TWA 00003 / 0000 00							
Z-Nr.: 1012 G						Blatt	
						-	
						Bl	
						25.01.2006	

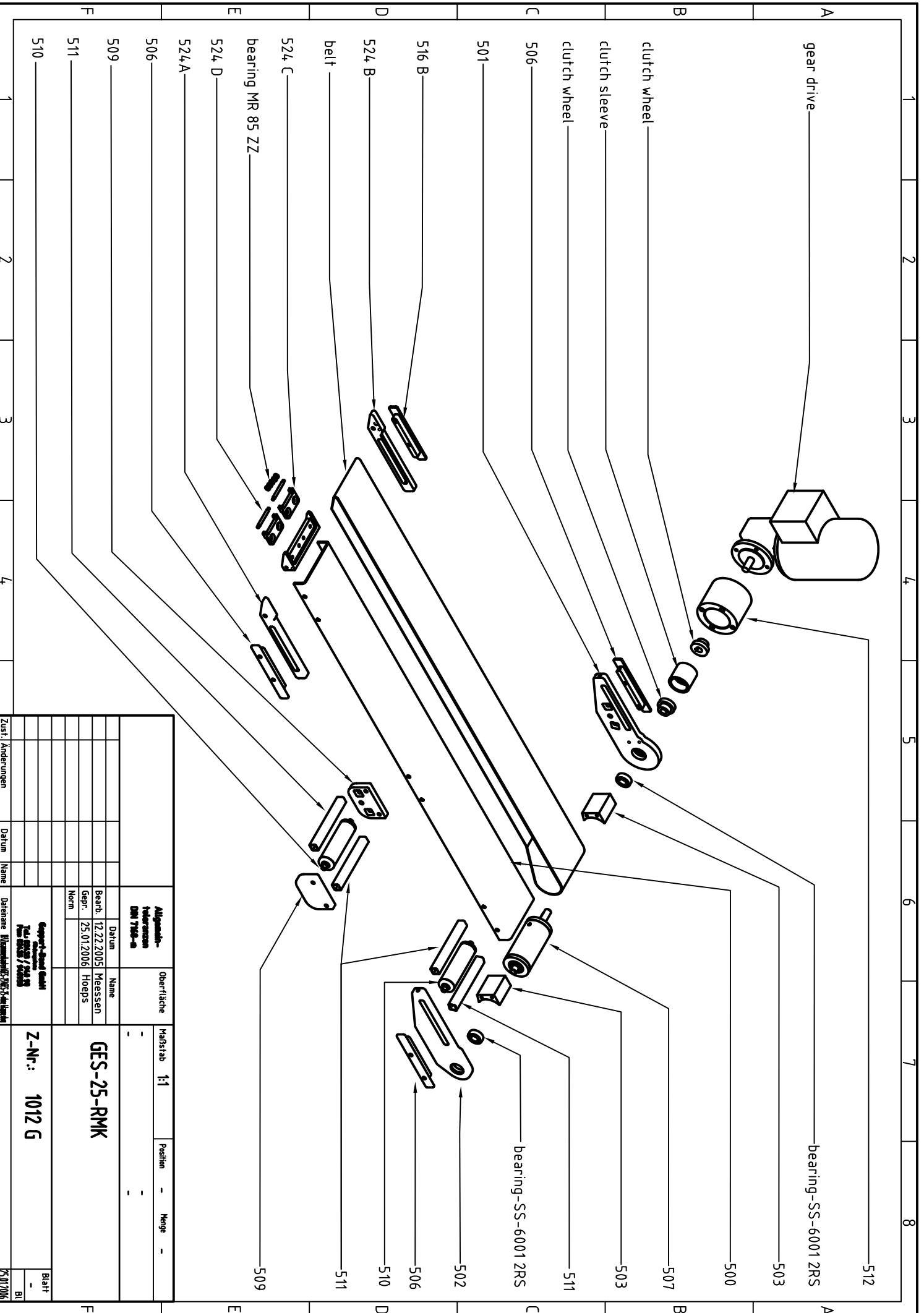

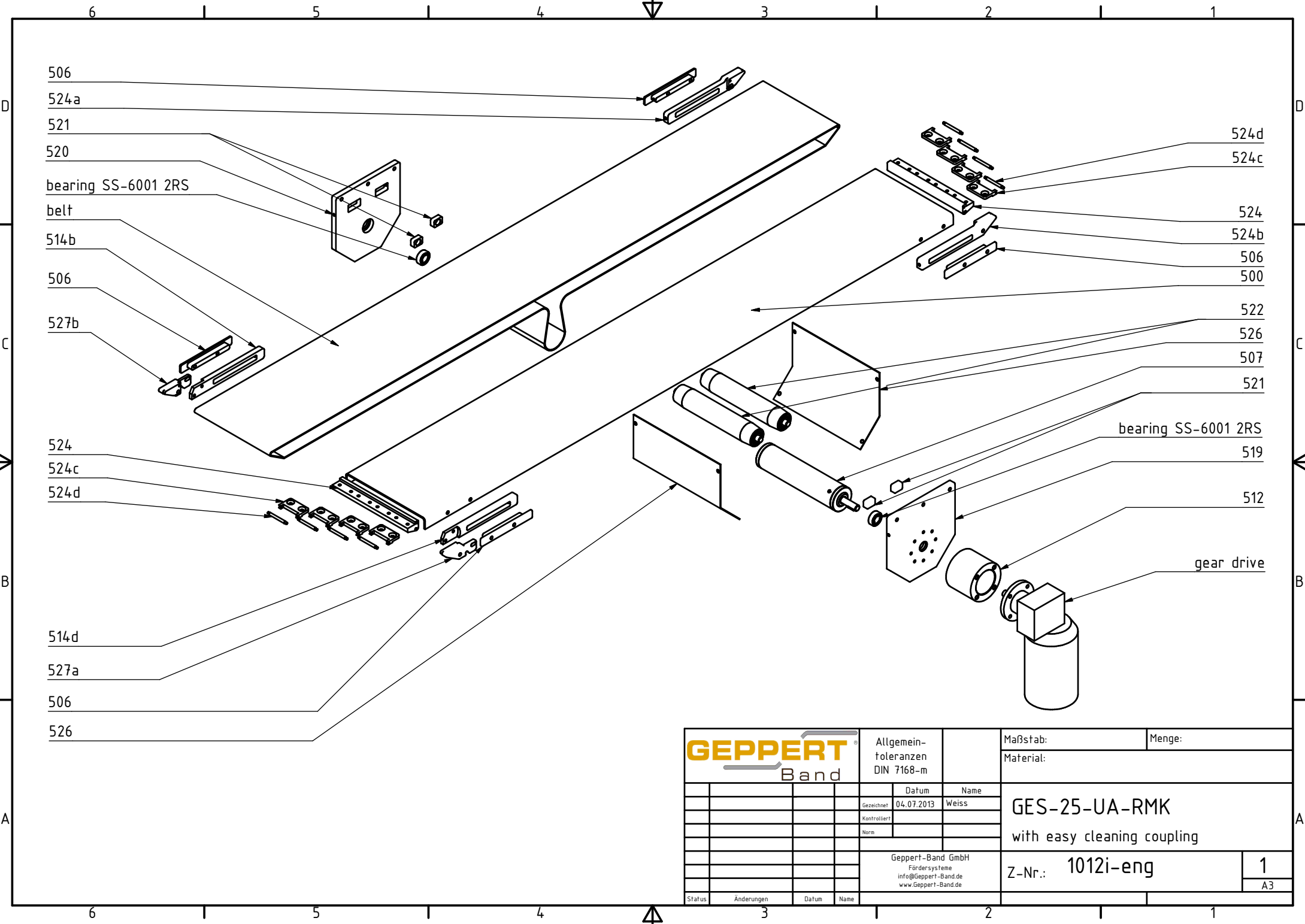
		Allgemeintoleranzen DIN 7168-m		Maßstab:	Menge:
				Material:	
	Datum	Name		<b>GES-25-UA-RMK</b> with easy cleaning coupling	
	04.07.2013	Weiss			
	Kontr. / Norm				
Geppert-Band GmbH Fördersysteme info@Geppert-Band.de www.Geppert-Band.de				Z-Nr.: 1012i-eng	1
Status	Änderungen	Datum	Name	A3	